

BP7614000  
BP7714000

EN OVEN

USER MANUAL

## FOR PERFECT RESULTS

Thank you for choosing this AEG product. We have created it to give you impeccable performance for many years, with innovative technologies that help make life simpler – features you might not find on ordinary appliances. Please spend a few minutes reading to get the very best from it.

## ACCESSORIES AND CONSUMABLES

In the AEG webshop, you'll find everything you need to keep all your AEG appliances looking spotless and working perfectly. Along with a wide range of accessories designed and built to the high quality standards you would expect, from specialist cookware to cutlery baskets, from bottle holders to delicate laundry bags...



Visit the webshop at:  
[www.aeg.com/shop](http://www.aeg.com/shop)

# CONTENTS

4	Safety information
8	Product description
9	Before first use
10	Control panel
12	Daily use
14	Clock functions
16	Automatic programmes
18	Using the accessories
20	Additional functions
22	Care and cleaning
26	What to do if...
27	Installation
29	Environment concerns

The following symbols are used in this user manual:



Important information concerning your personal safety and information on how to avoid damaging the appliance.



General information and tips



Environmental information

Subject to change without notice



## SAFETY INFORMATION

Before the installation and use, read this manual carefully:

- For your personal safety and the safety of your property
- For the respect of the environment
- For the correct operation of the appliance.

Always keep these instructions with the appliance also if you move or sell it.

The manufacturer is not responsible if incorrect installation or use results in damage.

### Children and vulnerable people safety

- This appliance can be used by children aged from 8 years and above and persons with reduced physical, sensory or mental capabilities or lack of experience and knowledge if they have been given supervision or instruction concerning use of the appliance in safe way and understand the hazards involved. Children shall not play with the appliance.
- Keep all packaging away from children. There is the risk of suffocation or physical injury.
- **WARNING:** Keep children and animals away from the appliance when the door is open or the appliance is in the operation, because it becomes hot. There is the risk of injury or other permanent disability.
- If the appliance has Child Lock or Key Lock (Control Lock) function, use it. It prevents children and animals from accidental operation of the appliance.

### General safety

- Do not change the specifications of this appliance. There is the risk of injury and damage to the appliance.
- Do not let the appliance stay unattended during operation.
- Switch off the appliance after each use.

### Installation

- Only an approved electrician can install and connect the appliance. Contact an approved service centre. This is to prevent the risks of structural damage or physical injury.
- Make sure that the appliance is not damaged because of transport. Do not connect a damaged appliance. If necessary, contact the supplier.
- Remove all packaging, stickers and layers from the appliance before first use. Do not remove the rating plate. It can invalidate the guarantee.
- Fully obey the laws, ordinances, directives and standards in force in the country where you use the appliance (safety regulations, recycling regulations, electrical or gas safety rules etc.).
- Make sure that the appliance is disconnected from the power supply during the installation.
- Be careful when you move the appliance. The appliance is heavy. Always use safety gloves. Do not pull the appliance by the handle.
- The electrical installation must have an isolation device which lets you disconnect the appliance from the mains at all poles. The isolation device must have a contact opening width of minimum 3 mm.

- You must have correct isolation devices: line protecting cut-outs, fuses (screw type fuses removed from the holder), earth leakage trips and contactors.
- The shock protection parts must be fixed in such a way that they cannot be undone without tools.
- Before the installation, make sure that the kitchen cabinet has the recess dimensions applicable.
- Make sure that the appliance is installed below and adjacent safe structures.
- Keep the minimum distances to the other appliances and units.
- Install the appliance with its back and one side close to the higher appliance. The other side must be close to appliance with the same height.
- The appliance cannot be positioned on a base.
- Built in ovens and built in cooking surfaces are attached with special connection system. To prevent damage to the appliance, only use an appliance with the appliances from the same manufacturer.

## Electrical connection

- The appliance must be earthed.
- Make sure that the electrical data on the rating plate agree with your domestic power supply.
- Information on the voltage is on the rating plate.
- Always use a correctly installed shockproof socket.
- When you connect electrical appliances to mains sockets, do not let cables touch or come near the hot appliance door.
- Do not use multi-way plugs, connectors and extension cables. There is the risk of fire.
- Do not replace or change the mains cable. Contact the service centre.
- Make sure not to squash or cause damage to the mains plug (if applicable) and cable behind the appliance.
- Make sure that the mains connection is accessible after the installation.
- Do not pull the mains cable to disconnect the appliance. Always pull the mains plug – if applicable.

## Use

- The appliance is only for domestic use. Do not use the appliance for commercial and industrial use.
- Only use the appliance for domestic cooking tasks. This is to prevent physical injury to persons or prevent damage to property.
- Do not use the appliance as a work surface or storage surface.
- Do not put flammable products or items that are wet with flammable products, and/or fusible objects (made of plastic or aluminium) in, near or on the appliance. There is the risk of explosion or fire.
- The interior of the appliance becomes hot during use. There is the risk of burns. Do not touch the heating elements in the appliance. Use gloves when you insert or remove the accessories or pots.

- Be careful when you remove or install the accessories to prevent damage to the oven enamel.
- Always stay away from the appliance when you open the door while the appliance is in operation. Hot steam can release. There is the risk of skin burns.
- Discoloration of the enamel has no effect on the performance of the appliance so it is not a defect in the sense of the warranty law.
- To prevent damage or discoloration to the enamel:
  - do not put any objects directly on the appliance floor and do not cover it with aluminium foil;
  - do not put hot water directly into the appliance;
  - do not keep moist dishes and food in the appliance after you finish the cooking.
- Do not use this appliance if it is in contact with water. Do not operate the appliance with wet hands.
- Do not apply pressure on the open door.
- Always close the appliance door when you cook, even while grilling.

## Care and cleaning

- Before maintenance, switch off the appliance and disconnect the appliance from the power supply.
- Before maintenance, make sure that the appliance is cold. There is the risk of burns. There is the risk that the glass panels can break.
- Keep the appliance clean at all times. A build-up of fats or other foodstuff can result in a fire.
- Regular cleaning prevents the surface material from deteriorating
- Use a deep baking tray for very moist cakes to prevent that fruit juices cause stains that can be permanent.
- For your personal safety and the safety of your property, only clean the appliance with water and a soap. Do not use flammable products or products that can cause corrosion.
- Do not clean the appliance with steam cleaners, high-pressure cleaners, sharp objects, abrasive cleaning agents, abrasive sponges and stain removers
- If you use an oven spray, follow the instructions from the manufacturer.
- Do not clean the glass door with abrasive cleaning agents or metal scraper. Heat resistant surface of the inner glass can break and shatter.
- When the door glass panels are damaged they become weak and can break. You must replace them. Contact the service centre.
- Be careful when you remove the door from the appliance. The door is heavy!
- Do not clean catalytic enamel (if applicable).

## Pyrolytic cleaning

- Do not leave the appliance unattended during Pyrolytic cleaning.
- Do not try to open the door and do not cut the power supply during Pyrolytic cleaning.
- Keep children away during pyrolytic cleaning. The appliance becomes very hot. There is the risk of burns.

- During pyrolytic cleaning, stubborn dirt can cause discoloration to the enamel. Discoloration to the enamel has no effect on the performance of the appliance

### Risk of fire

- Open the door carefully. The use of ingredients with alcohol can cause a mixture of alcohol and air. There is the risk of fire.
- Do not let sparks or open flames come near the appliance when you open the door.
- Do not put flammable products or items that are wet with flammable products, and/or fusible objects (made of plastic or aluminium) in, near or on the appliance.

### Oven lamp

- Bulb lamps used in this appliance are special lamps selected for household appliances use only. They cannot be used for the full or partial illumination of a household room.
- If it becomes necessary to replace the lamp use one of the same power and specifically designed for household appliances only.
- Disconnect the appliance from the power supply before the replacement of the oven lamp. There is the risk of electrical shock.

### Service centre

- Only an approved engineer can repair or work on the appliance. Contact an approved service centre.
- Use only original spare parts.

### Disposal of the appliance

- To prevent the risk of physical injury or damage
  - Disconnect the appliance from the power supply.
  - Cut off the mains cable and discard it.
  - Discard the door catch. This prevents children or small animals from being closed inside of the appliance. There is the risk of suffocation.

## PRODUCT DESCRIPTION

### General overview

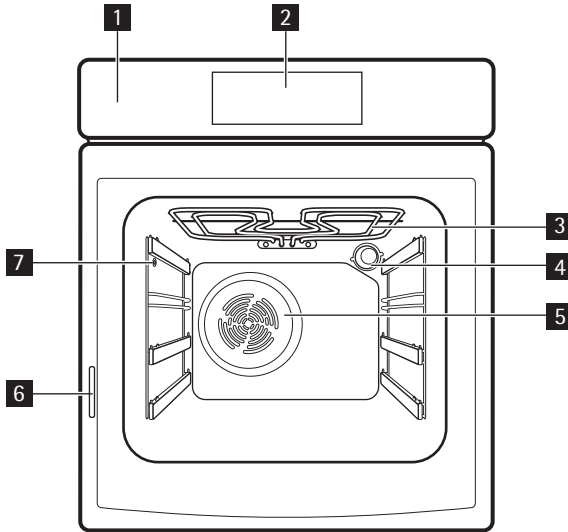

- 1** Control panel
- 2** Electronic programmer
- 3** Grill
- 4** Oven lamp
- 5** Fan
- 6** Rating plate
- 7** Socket for the core temperature sensor

### Oven accessories

- **Wire shelf**  
For cookware, cake tins, roasts.
- **Deep roasting pan**  
To bake and roast or as pan to collect fat.
- **The roasting pan grid**  
To put in the deep roasting pan.
- **Core Temperature Sensor**  
To measure how far the food is cooked.
- **Telescopic runners**  
To put the shelves or trays on it.



## BEFORE FIRST USE



### WARNING!

Refer to "Safety information" chapter.

### Initial Cleaning

- Remove all parts from the appliance.
- Clean the appliance before first use.



Refer to chapter "Care and Cleaning".









### First connection to the mains

After first connection to the mains all symbols in the display are on for some seconds. For the subsequent few seconds the display shows software version.

### First setting the time of day

After the software version goes off, the display shows "h" and "12:00".

Setting the time of day:



1. Touch  or  to set hours.
  2. Touch  or .
  3. Touch  or  to set minutes.
  4. Touch  or .
- The Temperature/Time display shows new time.

Changing the time of day

You can change the time of day only if the appliance is off.

Touch .  flashes in the display. To set new time of day use the above procedure.

### Pre-heating

1. Set function  and maximum temperature.
  2. Let the appliance operate without the food for approximately 1 hour.
  3. Set function  and maximum temperature.
  4. Let the appliance operate without the food for approximately 10 minutes.
  5. Set function  and maximum temperature.
  6. Let the appliance operate without the food for approximately 10 minutes.
- This is to burn off the residue in the appliance. The accessories can become more hot than usually. When you pre-heat the appliance for the first time, the appliance can make an odour and smoke. This is the usual effect. Make sure the airflow is sufficient.

## CONTROL PANEL

### Electronic programmer

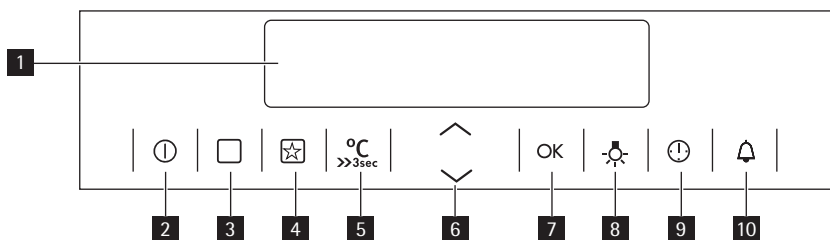

Use the sensor fields to operate the appliance.

	Sensor Field	Function	Description
1	-	DISPLAY	Shows the current settings of the appliance.
2		ON/OFF	To activate and deactivate the appliance.
3		OPTIONS	To set an oven function or programme. Straight access to the oven function when the appliance is off.
4		MY FAVOURITE PROGRAMME	You can store your favourite programme. Use it to access your favourite programme directly, also when the appliance is off.
5		TEMPERATURE / FAST HEAT UP	To set and examine cavity temperature or core temperature sensor temperature. If you press it and hold for three seconds, it turns Fast heat up function ON and OFF. Straight access to the temperature setting of the first oven function when the appliance is off.
6		UP, DOWN	To choose an oven function, clock function and to set the minute minder, temperature or time of day.
7		OK	To confirms the selection or setting.
8		OVEN LIGHT	To set the oven lamp on or off.
9		CLOCK	To set the clock function.
10		MINUTE MINDER	To set the minute minder.

## Display

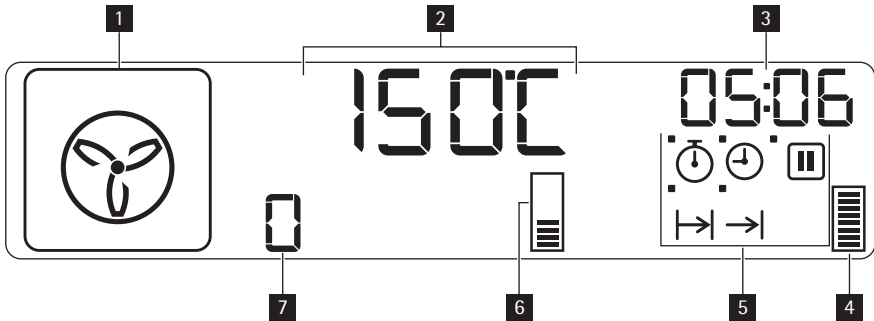

- 1** Oven function symbol
- 2** Temperature/Time display
- 3** Clock/Residual heat display (also Minute minder and Time of day)
- 4** Residual heat indicator
- 5** Indicators for the clock functions (refer to the table "Clock functions")
- 6** Heat up indicator
- 7** Number of oven function/programme

## Other indicators of display

Symbols	Name	Description
	Function	You can choose an oven function.
	Automatic programme	You can choose an oven programme.
	My favourite programme	The favourite programme operates.
<b>kg / gr</b>	kg/gr	An oven programme with weight input operates.
<b>h / min</b>	h/min	A clock function operates.
	Temperature / fast heat up	The function operates.
	Temperature	You can examine or change the temperature.
	Core temperature sensor	The core temperature sensor is in the core temperature sensor socket.
	Door lock	The door lock function operates.
	Oven light	The oven light is off.
	Minute minder	The minute minder function operates.

## Heat up indicator

If you set an oven function, the bars in the display come on one by one. The bars show that the temperature in the appliance increases or decreases.

When the appliance is at the set temperature, an acoustic signal sounds and the Heat up indicator goes off the display.

## Residual heat indicator

Display shows the residual heat indicator (residual heat symbol) after end of every cooking sessions when the temperature inside oven cavity is more then 40°C. Display also shows the oven temperature.

## DAILY USE



### WARNING!

Refer to "Safety information" chapter.



To operate the appliance you can use:

- **manual mode** -to set an oven function, the temperature and the cooking time manually.
- **automatic programmes** -to prepare a dish when you do not have a knowledge or experience in cooking.



## Setting the oven function







1. Touch .





The display shows a preset temperature, symbol and number of the oven function.  flashes in the display.

2. Touch  or  to set an oven function.
3. Touch  or the appliance starts automatically after five seconds.



If you activate the appliance with  or  and do not set any oven function or programme the appliance will deactivate automatically after 20 seconds.

	Oven function	Application
1	 True Fan Cooking	To bake maximum on two shelf positions at the same time. Decrease the oven temperatures (20-40 °C) compared with Conventional. And to dry food.
2	 Pizza Setting	To bake on one shelf position food with a more intensive browning and a crispy base. Decrease the oven temperatures (20-40 °C) compared with Conventional cooking.
3	 Slow Cook	To prepare very lean, tender roasted food. You can set the temperature between 80 °C -150 °C.
4	 Conventional Cooking	To bake and roast food on one shelf position.
5	 Turbo Grilling	To roast larger meat joints or poultry with bones on one shelf position. Also to gratinate and to brown.
6	 Fast Grilling	To grill flat food in large quantities. To toast bread.
7	 Grilling	To grill flat food in the middle of the grill. To toast bread.

Oven function			Application
8		Keep Warm	To keep the food warm. The set temperature is 80 °C and you cannot change it.
9		Defrost	To defrost frozen food. The set temperature is 30 °C and you cannot change it.
10		Bottom Heat	To bake cakes with a crispy base, and to preserve food.
11		Pyro Cleaning	For automatic pyrolytic cleaning of the oven. The oven temperature is at approximately 500° C. It burns off residual dirt in the oven. This can then be removed with a cloth when the oven is cold.

## Changing the oven temperature

Touch  $\wedge$  /  $\vee$  to change the temperature in steps of 5 °C.

When the appliance is at the set temperature, an acoustic signal operates three times and the Heat up indicator goes off.

## Examining the oven temperature

You can examine the temperature in the appliance when the function or programme operates.

1. Touch  $\gg_{3sec}^{\circ C}$ .

The Temperature/Time display shows the temperature in the appliance.



If you want to change the oven temperature, touch  $\gg_{3sec}^{\circ C}$  one more time and use  $\vee$  or  $\wedge$ .

2. Touch OK to go back to the set temperature or the display will show it automatically after five seconds.

## Fast heat up function

The fast heat up function decreases the heat up time.



Do not put food in the oven when the fast heat up function operates.

**Activating the fast heat up function:** Touch and hold  $\gg_{3sec}^{\circ C}$  for more than three seconds. If you activate the fast heat up function, the bars on the display  flash one by one to show that the function operates.



The fast heat up does not start with automatic programmes.

## Error code

If some parameters are not correct, the control unit stops the functions which operate and the display shows the related error code. Refer to "What to do if" chapter.



In case of a power cut, most of the settings are cancelled. Reset the settings when the power supply is restored.

## Energy saving



The appliance has same features that help you save energy during everyday cooking:

- Residual heat:
  - the oven function or programme operates: the heating elements are deactivated 10% time earlier (the lamp and fan continue to operate). The condition: the cooking time is longer then 30 minutes or you use the clock functions (Duration, End, Time delay).
  - the oven is off: you can use the heat to keep the food warm. The indication: the clock/ Residual heat display shows the remaining temperature, the bars show the decreasing temperature.
- Oven lamp off - touch to deactivate the oven lamp during cooking;
- Display off - if necessary, deactivate the appliance. Touch and at the same time until the display goes out (or on).

## CLOCK FUNCTIONS

SYMBOL	FUNCTION	DESCRIPTION
	COUNT UP TIMER	To set count up. It shows how long the appliance operates. This function has no effect on the operation of the appliance.
	TIME OF DAY	To examine the time of day. For changing the time of day refer to 'Setting the time of day'.
	DURATION	To set how long the appliance operates.
	END	To set when the appliance deactivates. You can use Duration and End at the same time (Time delay), if the appliance is to be activate and deactivate automatically later.
	SET+GO	To start the appliance with necessary settings with only one touch of the sensor field, any time later.

### Count Up Timer

Use the Count Up Timer to monitor how long the appliance operates. It is on immediately when the appliance starts to heat.

**Reset the Count Up Timer:** touch again and again until flashes in the display. Touch until the display shows "00:00" and the Count Up Timer starts to count up again.



You can not use Count Up Timer when Duration or End is set.

### Setting the DURATION

1. Activate the appliance and set an oven function and temperature.
2. Touch again and again until the display shows . flashes in the display.

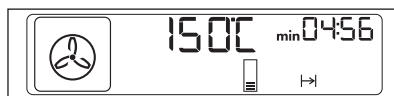

3. Use  $\wedge$  or  $\vee$  to set minutes for DURATION.
4. Touch **OK** to confirm
5. Use  $\wedge$  or  $\vee$  to set hours for DURATION. After 5 seconds the appliance starts.



If you touch  $\text{!}$  or **OK** during setting hours for DURATION, the appliance goes to setting of the END function.

6. When the set time ends, an acoustic signal operates for two minutes.  
 $\rightarrow|$  symbol and time setting flash in the display. The appliance deactivates.  
 Touch any sensor field or open the oven door to stop an acoustic signal.
7. Deactivate the appliance.

## Setting the END

1. Activate the appliance and set an oven function and temperature.
2. Touch  $\text{!}$  again and again until the display shows  $\rightarrow|$ .  
 $\rightarrow|$  flashes in the display.
3. Use  $\wedge$  or  $\vee$  to set END (first you set minutes and then hours) and **OK** or  $\text{!}$  to confirm.
4. When the set time ends, an acoustic signal operates for two minutes.  
 $\rightarrow|$  symbol and time setting flash in the display. The appliance deactivates.
5. Touch any sensor field or open the oven door to stop an acoustic signal.
6. Deactivate the appliance.

## Setting the SET+GO

To start of the appliance with necessary settings with only one touch of the sensor field, any time later.

1. Set an oven function (or programme) and temperature (refer to "Setting the oven function" and "Changing the oven temperature").
2. Set DURATION (refer to "Setting the DURATION").
3. Touch  $\text{!}$  again and again until  $\text{||}$  will flash in the display.
4. Touch **OK** to set the SET+GO function.  
 The display shows  $\rightarrow|$  and  $\text{||}$  with a dot. This dot shows which clock function is activated.
5. Touch any sensor field (apart from ON/OFF) to start the SET+GO function.



You can use SET+GO function only if DURATION is set.





## Setting the Time delay function

DURATION  $\rightarrow|$  and END  $\rightarrow|$  can be used at the same time, if the oven is to be switched on and off automatically later. In this case first set DURATION  $\rightarrow|$  and then END  $\rightarrow|$  function (refer to "Setting the DURATION" and "Setting the END").

When the Time delay function is activated the display shows static symbol of the oven function,  $\rightarrow|$  with a dot and  $\rightarrow|$ . The dot shows which clock function is on in the Clock/Residual heat display.

## Setting the MINUTE MINDER

Use the MINUTE MINDER to set a countdown (maximum 23 h 59 min). This function has no effect on the operation of the oven. You can set the MINUTE MINDER any time, also if the appliance is off.

1. Touch  .  
 and "00" flash in the display.
2. Use  or  to set MINUTE MINDER. First you set seconds and then minutes and hours.
3. Touch **OK** or the MINUTE MINDER starts automatically after five seconds.
4. When set time ends, an acoustic signal operates for two minutes and "00:00" and  flash in the display.
5. Touch any sensor field or open the oven door to stop an acoustic signal.



## AUTOMATIC PROGRAMMES



### WARNING!

Refer to "Safety information" chapter.







There are 20 automatic programmes and recipes. Use an automatic programme or recipe when you do not have a knowledge or experience how to prepare a dish. You can find the recipes for the automatic programmes in the "Recipe book".

There are three types of automatic programmes:

- Automatic recipes;
- Automatic programmes with weight input;
- Automatic programmes with core temperature sensor;

### Automatic recipes

Setting an automatic recipe:







1. Touch  two times until the display shows  .  
 The display shows symbol and number of the automatic programme.
2. Touch  or  to choose the automatic recipes.
3. Touch **OK** or the automatic recipe activates automatically after five seconds.
4. When set time ends, an acoustic signal operates for two minutes. Symbol  flashes.  
 The appliance deactivates.
5. Touch any sensor field or open the oven door to stop an acoustic signal.

### Automatic programmes with weight input

If you set the weight of the meat, the appliance calculates the roasting time.





1. Touch  again and again until the display shows  .



2. Touch  or  to set the weight programme (refer to "Recipe book").  
The display shows: cooking time, duration symbol , a default weight, a unit of measurement (kg, g).
3. Touch **OK** or the settings save automatically after five seconds.
4. The appliance starts. A symbol of the weight unit flashes in the display. During this time you can change the default weight value with  or . Touch **OK**.
5. When set time ends, an acoustic signal operates for two minutes.  flashes.  
The appliance deactivates.
6. Touch any sensor field or open the oven door to stop an acoustic signal.



## Automatic programmes with core temperature sensor

The core temperature of the food is default and fixed in programmes with core temperature sensor. The programme ends when the appliance is at the set core temperature.

1. Touch  again and again until the display shows .
2. Install the core temperature sensor (refer to "The core temperature sensor").
3. Touch  or  to set the core temperature sensor programme.



The core temperature sensor does not work with Slow cook, Keep warm and Bottom heat.

When a core temperature sensor programme is set, the display shows the cooking time,  and .



4. Touch **OK** or the settings save automatically after five seconds.
5. When the food is at the set core temperature, the core temperature and  flash. An acoustic signal sounds for two minutes.  
The appliance deactivates.
6. Touch any sensor field or open the oven door to stop an acoustic signal.

## My Favourite Programme function

Use this function to save your favourite settings of temperature and time for an oven function or programme.

1. Set the temperature and time for an oven function or programme.
2. Touch and hold  for more than three seconds.  
An acoustic signal sounds.
3. Deactivate the appliance.

Using My Favourite Programme function:

- To activate the function touch . The appliance activates your favourite programme.
- To deactivate the function touch . The appliance deactivates your favourite programme.



When the function operates, you can change the time and temperature.

## USING THE ACCESSORIES



### WARNING!

Refer to "Safety information" chapter.

### The core temperature sensor

The core temperature sensor measures the core temperature of the meat. When the meat is at the set temperature, the cooking programme deactivates.

There are two temperatures to set:



- The oven temperature: refer to the table for roasting in the recipe book.
- The core temperature: refer to the table for the core temperature sensor in the recipe book.







Only use the core temperature sensor supplied or original replacement parts.

1. Activate the appliance.
2. Put the point of the core temperature sensor in the centre of the meat.
3. Put the plug of the core temperature sensor in the socket at the side wall of the appliance.

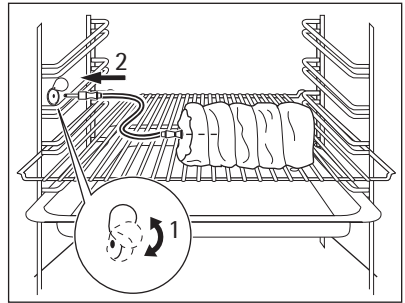
The display shows a flashing symbol  and the default set core temperature. The temperature is 60 °C during the first use, and the last set value during each subsequent use.

4. Touch  or  to set the core temperature.
5. Touch **OK** or the settings save automatically after 5 seconds.



You can set the core temperature only when the symbol  flashes. If the display shows a static symbol  before you set the core temperature, use  $\gg_{3sec}$  and  or  to set a new value.

6. Set the oven function and, if necessary, the oven temperature.

The display shows the current core temperature and  (which shows the relation between the set oven temperature and the current oven temperature).



The core temperature sensor must stay in the meat and in the socket during the cooking.



While the appliance calculates the approximate duration time, the value of the Count Up Timer function shows in the Timer/Residual heat display. When the first calculation ends, the Timer/Residual heat display shows "-", and then the approximate duration of the cooking.

The appliance continues to calculate the duration during the cooking. The display updates at intervals with the new duration value.

7. When the meat is at the set core temperature, the core temperature and  flash. The appliance deactivates. An acoustic signal sounds for two minutes. Touch on/off sensor field to deactivate the acoustic signal.



### WARNING!

Be careful when you remove the core temperature sensor. The core temperature sensor and the appliance are hot. There is a risk of burns.

8. Remove the core temperature sensor from the socket and remove the meat from the appliance.



When you put the core temperature sensor in the socket, you cancel the settings for the clock functions.



When you cook with the core temperature sensor, you can change the temperature shown in the Temperature/Time display. After you put the core temperature sensor in the socket and set an oven function and temperature, the display shows the current core temperature.

Touch  $\gg_{3sec}^{\circ C}$  again and again to see three other temperatures:

- The current core temperature
- The oven set temperature
- The current oven temperature.

## Telescopic runners

With telescopic runners you can put and remove the shelves more easily.

1. Pull out the right and left hand telescopic runners.

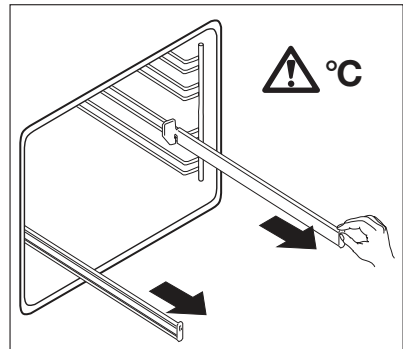

- Put the oven shelf on the telescopic runners and carefully push them in the appliance.  
Make sure you push back the telescopic runners fully in the appliance before you close the oven door.

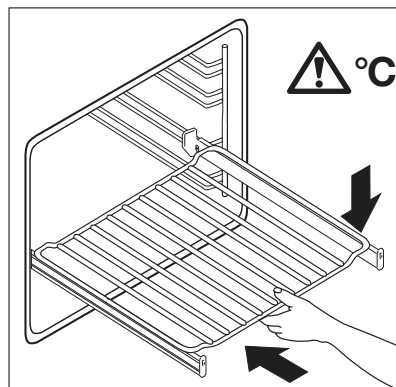
**CAUTION!**



Do not clean the telescopic runners in the dishwasher. Do not lubricate the telescopic runners.

## ADDITIONAL FUNCTIONS

### Child safety

You cannot activate the appliance on if the child safety device operates.

Activating/Deactivating the child safety device:

- Deactivate the appliance . Do not set any oven function.
- Touch and hold  and  at the same time for minimum 2 seconds.
- An acoustic signal sounds.



When the Child safety is on, the door is locked.  
SAFE goes on in the display when you touch any key.



### Control Lock

The Control Lock prevents you to accidentally change the oven functions.





You can activate the Control Lock only when the appliance operates.

Activate the Control Lock:

- If necessary, activate the appliance.
- Do the necessary settings.
- Touch and hold  and  at the same time.

Loc goes on in the display. The Control Lock is on.

To deactivate the Control Lock, touch and hold  and  at the same time.



The Control Lock does not prevent you accidentally deactivate the appliance. If you deactivate the appliance, the Control Lock is off.

### Settings menu

The settings menu lets you to add or remove functions from the main menu (for example: you can set on or off the Residual heat indicator). Settings menu has maximum eight set-

tings (from SET1 to SET8). The number of the settings is different for different models. Look into the table below to see the possible value of each setting.

### Settings menu







Indicator of the setting menu	Description	Value to set
SET1	SET+GO	ON/OFF
SET2	RESIDUAL HEAT INDICATOR	ON/OFF
SET3	CLEANING REMINDER	ON/OFF
SET4	KEY TONE	CLIC/BEEP/OFF
SET5	FAULTY TONE	ON/OFF
SET6	SERVICE MENU	---
SET7	RESTORE SETTINGS	YES/NO
SET8 <sup>1)</sup>	TIME EXTENSION	ON/OFF

1) Selected models only



You can set the settings menu only when the appliance is off.

Activate the Settings menu:

1. If necessary, deactivate the appliance .
2. Touch and hold  for three seconds.  
The display shows "SET1" and "1" flashes.
3. Touch  /  to set the setting.
4. Touch **OK** .
5. Touch  /  to change the value of the setting.
6. Touch **OK** .

### Automatic switch-off

The appliance deactivates after some time:

- if you do not deactivate the appliance;
- if you do not change the oven temperature.

Oven temperature	Switch-off time
30°C - 115°C	12,5 h
120°C - 195°C	8.5 h
200°C - 245°C	5.5 h
250°C	3.0 h

To operate the appliance after an automatic switch-off, first deactivate the appliance fully.

### Brightness of the display

There are two modes of display's brightness:

- Night brightness - when the appliance is off, the brightness of the display is lower between 22:00 and 06:00;

- Day brightness:
  - when the appliance is on;
  - if you touch any of the sensor fields during night brightness (apart from ON/OFF), the display goes back to day brightness mode for next 10 seconds;
  - if the appliance is off and you set the minute minder. When the minute minder function ends, the display goes back to night brightness;

## Cooling fan

When the appliance operates, the cooling fan activates automatically to keep the surfaces of the appliance cool. If you deactivate the appliance, the cooling fan can continue to operate until the appliance cools down.

## CARE AND CLEANING



### **WARNING!**

Refer to "Safety information" chapter.

### Notes on cleaning:

- Clean the front of the appliance with a soft cloth with warm water and cleaning agent.
- To clean metal surfaces use a usual cleaning agent
- Clean the oven interior after each use. Thus you can remove dirt more easily and it does not burn on.
- Clean stubborn dirt with a special oven cleaner.
- Clean all oven accessories (with a soft cloth with warm water and cleaning agent) after each use and let them dry.
- If you have nonstick accessories, do not clean them using an aggressive agents, sharp edged objects or dishwasher. It can cause a damage to the nonstick coating.

## Cleaning the door gasket

- Regularly do a check of the door gasket. The door gasket is around the frame of the oven cavity. Do not use the appliance if the door gasket is damaged. Contact the Service Centre.
- To clean the door gasket refer to the general information about the cleaning.



### **Stainless steel or aluminium appliances:**

Clean the oven door with a wet sponge only. Dry it with a soft cloth.

Do not use steel wool, acids or abrasive materials as they can damage the oven surface.



Clean the oven control panel with the same precautions

## Pyrolytic cleaning

1. Remove all parts from the appliance.



The pyrolytic cleaning procedure cannot start:

- If you do not remove the core temperature sensor plug from the socket, the display shows „C2“
  - If you do not close the oven door correctly, the display shows „C3“.
2. Remove the worst of the residual dirt manually.
  3. Set the Pyrolytic cleaning function  (refer to "Oven functions").
  4. Touch **OK** to activate the Pyro cleaning function.
  5. Touch  or  to set the duration of the cleaning procedure:
    - P1 1:30 for a low degree of dirt
    - P2 2:00 for a usual degree of dirt
    - P3 2:30 for a high degree of dirt.Touch **OK** to confirm.



You can use the End function to delay start of the cleaning process.

During the Pyro cleaning the door is locked. The symbol  and the bars of the heat indicator come up, until the door unlocks again. The door unlocks when temperature inside the oven is under safety condition and Pyro cleaning is finished.



During pyrolytic cleaning the lamp is off.

Cleaning reminder

To remind you that the pyrolytic cleaning is necessary the cleaning reminder symbol flashes in the display  after every deactivating the appliance for the next 10 seconds.



The cleaning reminder goes off from the display:

- After end of the pyrolytic cleaning function
- When you deactivate it in the Settings menu (refer to "Settings menu")

## Telescopic shelf runners

You can remove the telescopic runners to clean the side walls.

Removing the telescopic runners

1. Pull the front of the telescopic runners away from the side wall.

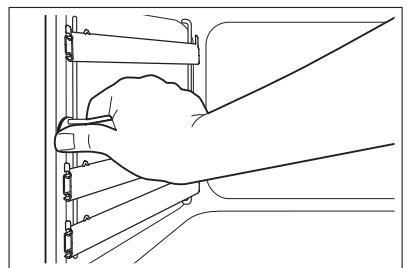

2. Pull the telescopic runners from the rear side of the wall and remove the telescopic runners.

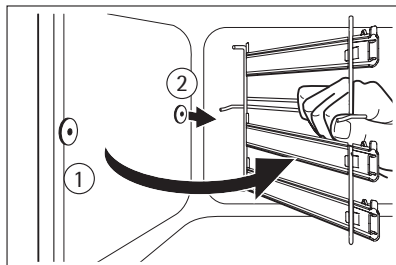

Installing the telescopic runners

Install the telescopic runners in the opposite sequence.



The retaining pins on the telescopic shelf runners must point to the front!



### CAUTION!

Do not clean the telescopic runners in the dishwasher. Do not lubricate the telescopic runners.

## Oven lamp



### WARNING!

Be careful! There is the risk of electrical shock!

Before you change the oven lamp:

- Switch off the oven.
- Remove the fuses in the fuse box or switch off the circuit breaker.



Put a cloth on the bottom of the oven for protection of the oven light and glass cover.

1. Turn the glass cover anti-clockwise to remove it.
2. Clean the glass cover.
3. Replace the oven light bulb with applicable 300°C heat-resistant oven light bulb.  
Use the same oven lamp type.
4. Install the glass cover.

## Cleaning the oven door

The oven door has four panels of glass. You can remove the internal panels of glass to clean them.



### Removing the glass panels

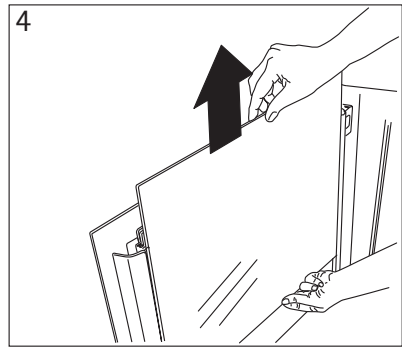
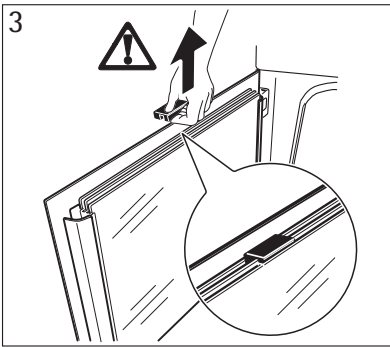
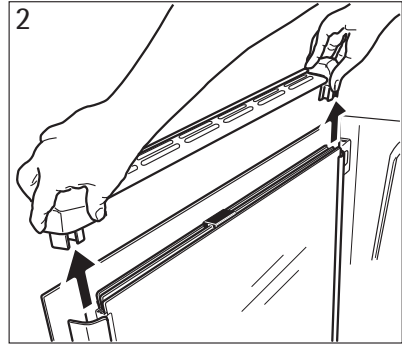
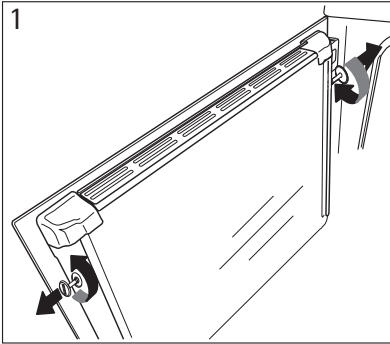

### Inserting the glass panels

After the cleaning, install the panels of glass in the opposite sequence.

**i** The oven door is not reversible.

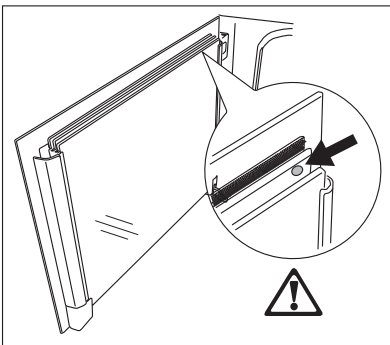

BP7714000M

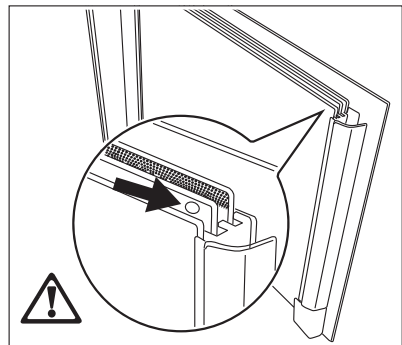

BP7614000M

Make sure you put the glass panels back in the correct order.

First glass panel has a black frame, the second a small dot on a upper right corner and the third one has no marking. Refer to the illustration.  
 When you assemble the panel with the black frame, make sure that the screen-printing (you can feel a roughness) on this panel faces the oven.  
 Make sure that you put the stop rubber as in the illustration.

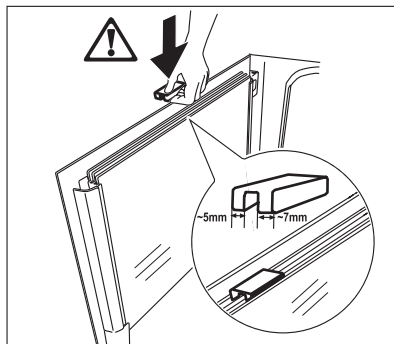



## WHAT TO DO IF...



### WARNING!

Refer to "Safety information" chapter.

Problem	Possible cause	Solution
The appliance does not heat up	The appliance is deactivated	Activate the appliance
	The time of day is not set.	Set the clock. Refer to "First setting the time of day"
	The necessary settings are not set	Make sure, the settings are correct
	The automatic switch-off is activated	Refer to „Automatic switch-off"
	The fuse is released	Make sure, if the fuse is the cause for the malfunction. If the fuse releases again and again, refer to an authorized electrician
	The "Demo" function is on.	Deactivate the "Demo" function. 1. Deactivate the appliance. 2. Touch and hold  until an acoustic signal sounds (for minimum 5 seconds). 3. Touch and hold  and  at the same time for 2 seconds until an acoustic signal sounds.

Problem	Possible cause	Solution
The oven lamp does not operate	The oven lamp is defective	Replace the oven lamp.
The display shows C2	You want to start the Pyrolytic cleaning, Keep warm or Defrost function but you did not remove core temperature sensor plug from the socket.	Remove the core temperature sensor plug from the socket.
The display shows C3	You want to start Pyrolytic cleaning but you did not close the oven door correctly.	Close the door correctly.
The display shows F102	The door lock is defect	<ul style="list-style-type: none"> <li>• Close the door correctly</li> <li>• Deactivate the appliance with the house fuse or the safety switch in the fuse box and activate it again</li> <li>• If the display shows F102 again, refer to the Customer Care Department</li> </ul>
The display shows an error code.	There is an electronic fault	<ul style="list-style-type: none"> <li>• Deactivate the appliance with the house fuse or the safety switch in the fuse box and activate it again</li> <li>• If the display shows the error code again, refer to the Customer Care Department</li> </ul>
Steam and condensation collect on the food and in the appliance.	You left the dish in the appliance for too long.	Do not let the dishes stay in the appliance for longer than 15-20 minutes after the cooking is completed.

If you cannot find a solution to the problem yourself, contact your dealer or the service centre.

The necessary data for the service centre is on the rating plate. The rating plate is on the front frame of the oven cavity.

We recommend that you write the data here:

Model (MOD.) .....

Product number (PNC) .....

Serial number (S.N.) .....

## INSTALLATION



### WARNING!

Refer to "Safety information" chapter.

## Building In

Overall oven dimensions

**1** Removable spacers

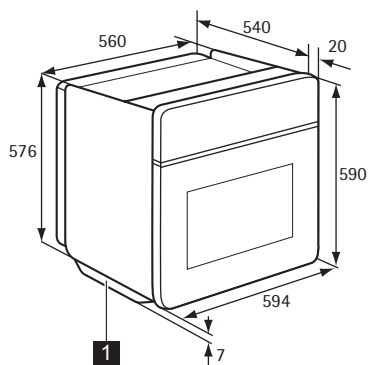

### In column building-in

Spacers removed

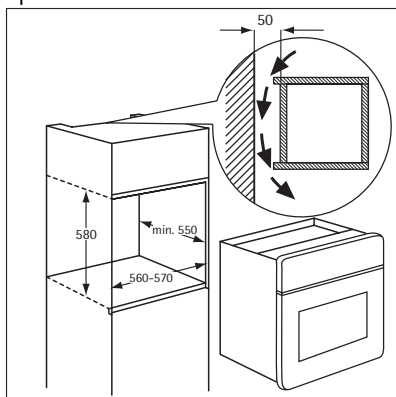

Spacers not removed

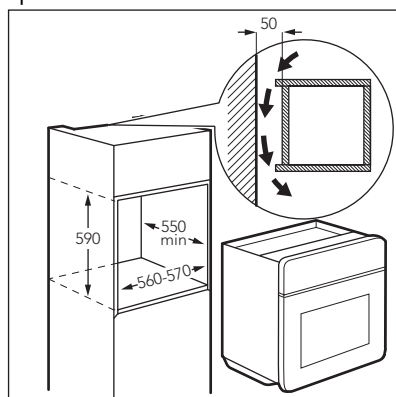

### Building-in under kitchen counter

Spacers removed

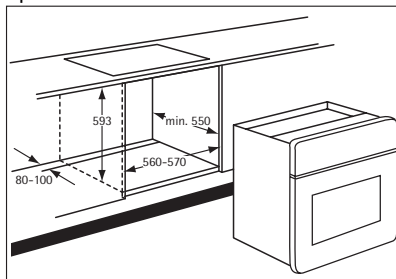

Spacers not removed

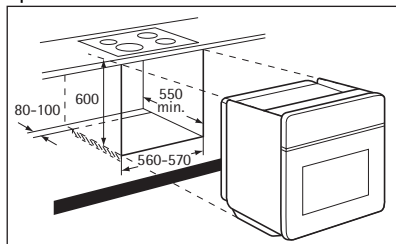

### Securing the appliance to the cabinet

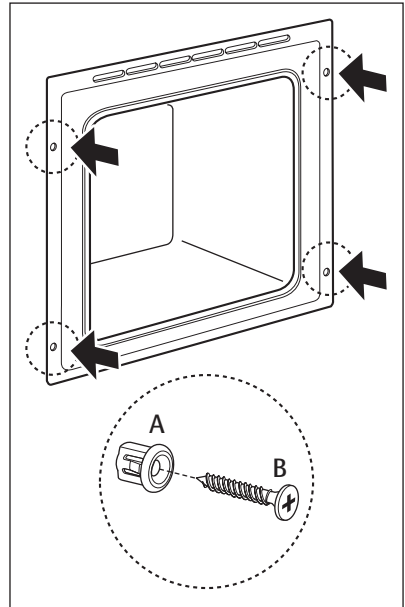

### Electrical installation



The manufacturer is not responsible if you do not obey the safety precautions from chapter "Safety".

This appliance is only supplied with a main cable.

Applicable types of cables for Europe:

- Minimum size Cable/flex: 1,5mm<sup>2</sup>
- Cable/ flex type: H07 RN-F, H05 RN-F, H05 RRF, H05 VV-F, H05 V2V2-F (T90), H05 BB-F
- Fuse 13 A

Applicable types of cables for UK only

Connection via	Min. size Cable/flex	Cable/flex type	Fuse
<ul style="list-style-type: none"> <li>• 13 A socket outlet</li> <li>• 13 A spur box</li> </ul>	2,5 mm <sup>2</sup>	Three core butyl insulated	13 A min.
Oven Control Circuit	2,5 mm <sup>2</sup>	PVC/PVC twin and earth	15 A min. 20 A min.

### ENVIRONMENT CONCERNS

The symbol  on the product or on its packaging indicates that this product may not be treated as household waste. Instead it should be taken to the appropriate collection point for the recycling of electrical and electronic equipment. By ensuring this product is disposed of correctly, you will help prevent potential negative consequences for the

environment and human health, which could otherwise be caused by inappropriate waste handling of this product. For more detailed information about recycling of this product, please contact your local council, your household waste disposal service or the shop where you purchased the product.



#### Packaging material

The packaging material is environmentally-friendly and recyclable. Plastic parts are marked with international abbreviations such as PE, PS, etc. Dispose of the packaging material in the containers provided for this purpose at your local waste management facility.



[www.aeg.com/shop](http://www.aeg.com/shop)

397203402-A-082011

